

PRODUCT DATASHEET

Recessed Panel light
HYD-102S-12W 4000K



Application

- Office
- Kitchen
- Rest room
- Corridor
- Shop

Benefits

- Flicker free.
- The light is soft and bright
- Drive stable, safe and reliable
- High light transmission mask to ensure uniform light

Features

- Efficient and durable
- Easy and quick installation
- Light body thin design, reduce space occupancy
- Die-cast aluminum body for better heat dissipation, anti-corrosion, and easy maintain

Electrical Data

Nominal wattage (W)	12W
Nominal Voltage (V)	220
Mains Frequency (Hz)	50
Nominal Current (mA)	98
LED Driver Current (mA)	300
LED Driver Voltage (VDC)	30-42
LED Driver Efficiency (%)	83%
Power Factor λ	0.55C
Total harmonic distortion (%)	...
Operating mode	External LED Driver

Photometrical data

Luminous flux $\pm 10\%$ (lm)	1088 lm
Luminous efficacy	91 lm/w
Color temperature	4000K
Light color (designation)	Natural White
Color rendering index Ra	≥ 80
Standard deviation of color matching	≤ 5 SDCM
Luminous intensity/cd	383
Flickering	Flicker free
Beam angle	112 °

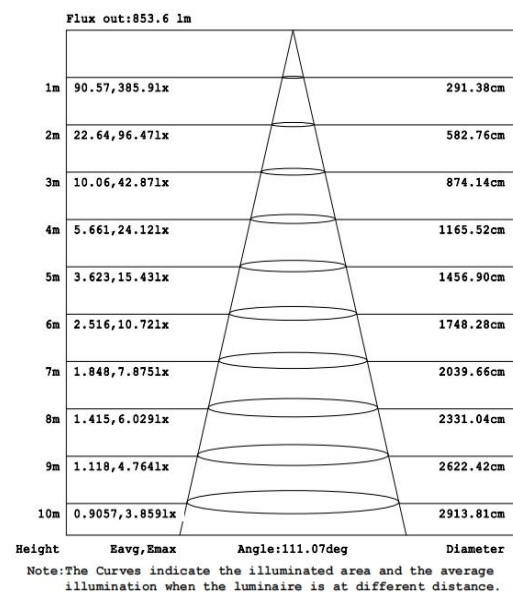
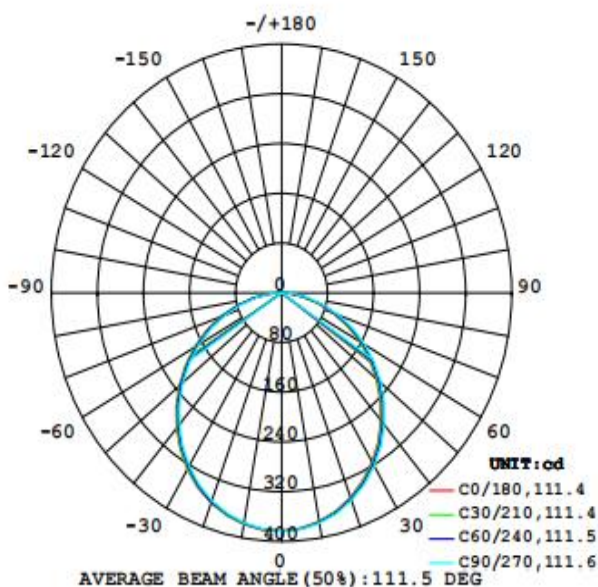

4000K

Dimensions & Weight

Diameter (mm)	171*171
Height (mm)	35
Product weight (g)	313

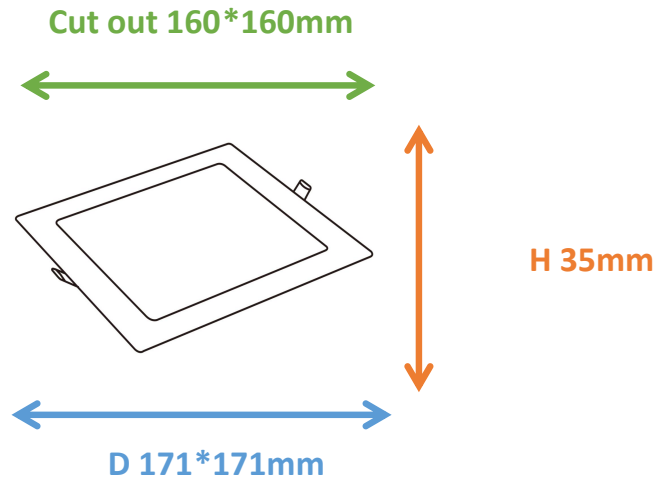

Material & Colors

Product color	All White
Housing color	White
Body material	Aluminum
Cover material	PS LGP material
Mercury content	0.0 mg

Application & Mounting

Ambient temperature range	-20°C~+45 °C
Temperature range at storage	-25°C~+60 °C
Type of connection	Screwless terminal
Type of protection	IP20
Dimmable	No
Mounting type	Recesse mounted
Mounting location	Ceiling
Application environment	Indoor
Cut size (mm)	160*160
LED module replaceable	Not replaceable
With light source	Yes

Certificates & Lifespan

Life (h)	50,000
Certificates	CB LVD EMC RoHS
Standards	ISO9001:2015

Logistical Data

Product code	Dimensions (L*W*H)	Pcs/ carton	G.W. kg	Volume CBM
HYD-102S-12W	45*23*37.5 cm	20	...	0.03881

Installation Method

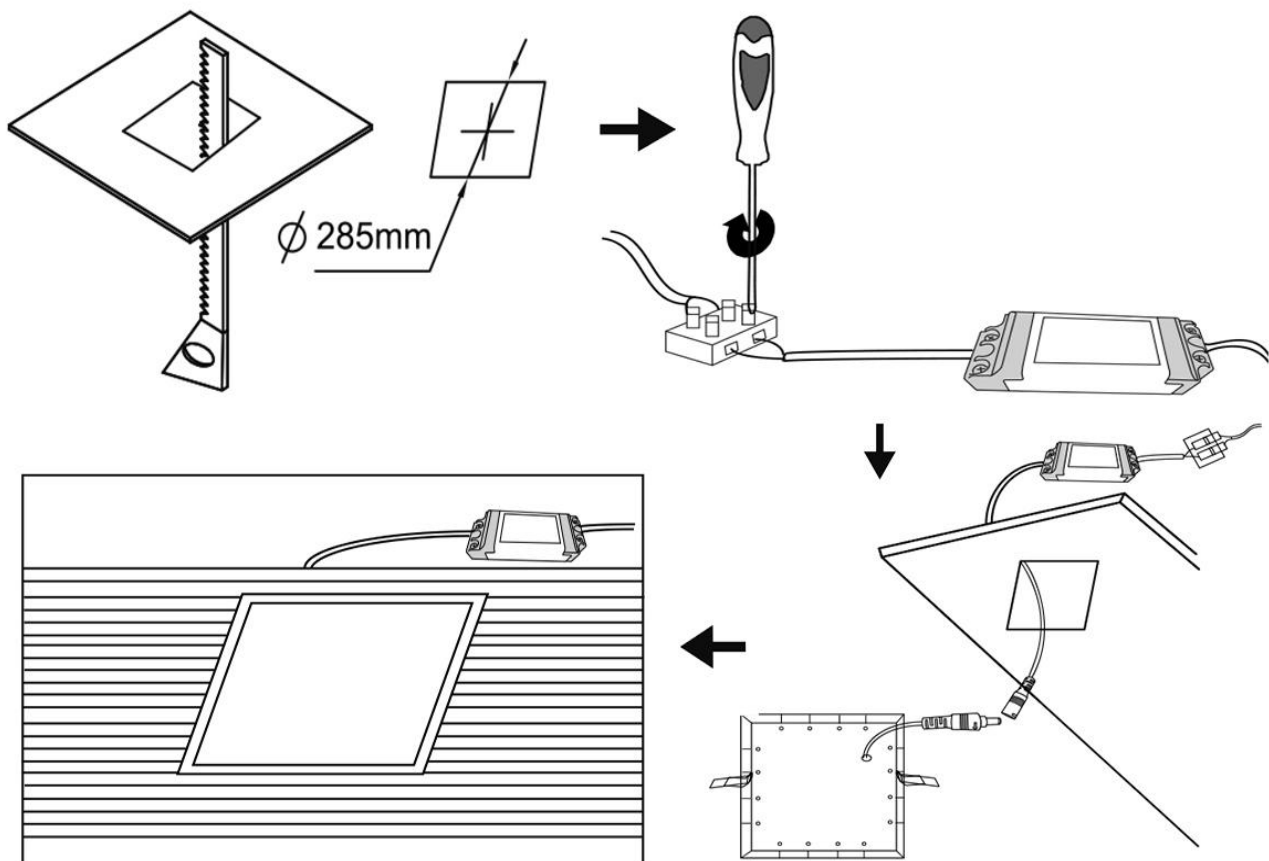

Disclaimer

Subject to change without notice. Errors and omission excepted. Always make sure to use the most recent release.